

FABRICATORS OF SPECIALTY STAINLESS STEEL PRODUCTS

AUTOPSY SINKS

BASSINETTES

CARTS

FOOD SERVICE EQUIPMENT

FUME HOODS

HOSPITAL CASEWORK

LABORATORY CASEWORK

NARCOTIC LOCKERS

NOURISHMENT STATIONS

O.R. CONSOLES

SHELVING

SINKS

TABLES

WARMING CABINETS

WORK TOPS

HOSPITAL – LABORATORY CASEWORK

ALL STAINLESS STEEL BASE AND WALL CABINETS

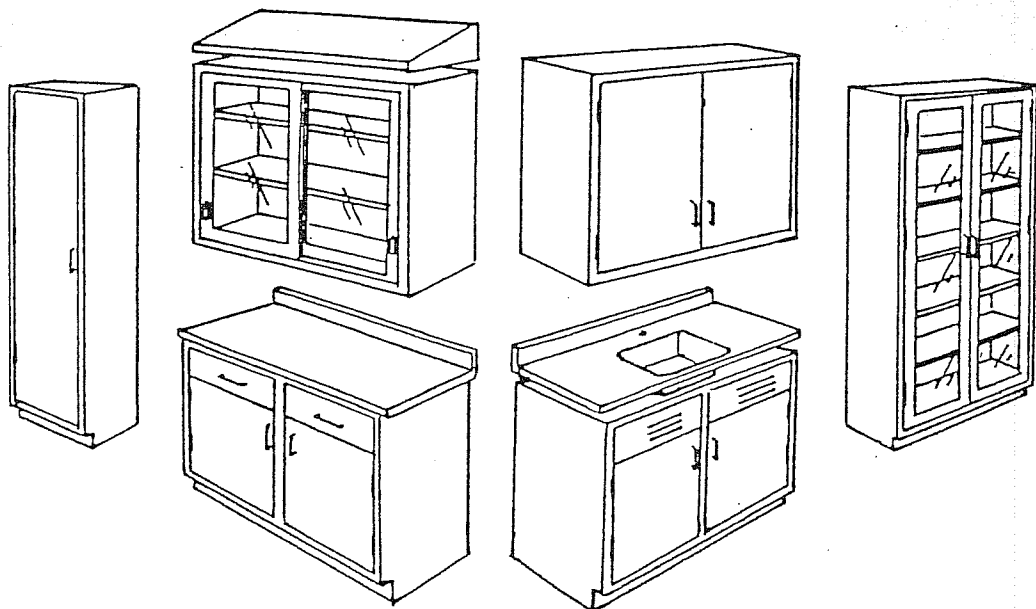

STAINLESS STEEL TYPE No. 304 18/8

Body and Shelves18Ga.
Work Tops16Ga.

Door Panels.....18Ga.
Drawer Body.....18Ga.

CABINET BODIES...Flush seamless welded front. All bends channel formed for rugged use.

DOORS...Flush mounted double walled - sound deadened - mounted on stainless steel hinges mortised into door body. Glass doors of 1/4" safety glass panels removable for replacement. Sliding doors on overhead roller bearings.

DRAWER...One piece body with double wall flush mounted insulated front, operating on stainless steel channel slides with nylon ball bearings.

SHELVES...Channel edges on all slides. Adjustable on 1/2" centers.

WORK TOPS...Die formed channel edges stiffened with steel channel under bracing..... Fully sound deadened. Priced separately.

ALL LUSTROUS SATIN FINISH.

STAINLESS STEEL BASE CABINETS

All Base Cabinets are 22" deep.

"H" Models are 35-1/4" high.

"L" Models are 29-1/4" high.

Model No. listed are left to right widths.

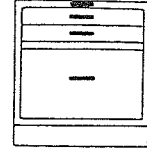

**3-DRAWERS
1 PULL SHELF**

- BSG-15L.....
- BSG-18H.....
- BSG-18L.....
- BSG-21H.....
- BSG-21L.....
- BSG-24H.....
- BSG-24L.....

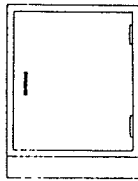

1-DOOR

- BSA-15H.....
- BSA-15L.....
- BSA-18H.....
- BSA-18L.....
- BSA-21H.....
- BSA-21L.....
- BSA-24H.....
- BSA-24L.....

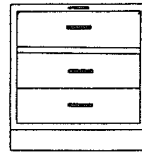

**3-DRAWERS
1 PULL SHELF**

- BSD-15H.....
- BSD-15L.....
- BSD-18H.....
- BSD-18L.....
- BSD-21H.....
- BSD-21L.....
- BSD-24H.....
- BSD-24L.....

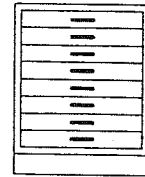

8-DRAWERS

- BSH-15H.....
- BSH-15L.....
- BSH-18H.....
- BSH-18L.....
- BSH-21H.....
- BSH-21L.....
- BSH-24H.....
- BSH-24L.....

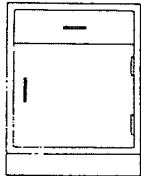

**1-DRAWER
1-DOOR**

- BSB-15H.....
- BSB-15L.....
- BSB-18H.....
- BSB-18L.....
- BSB-21H.....
- BSB-21L.....
- BSB-24H.....
- BSB-24L.....

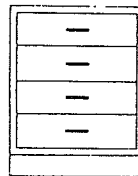

4-DRAWERS

- BSE-15H.....
- BSE-15L.....
- BSE-18H.....
- BSE-18L.....
- BSE-21H.....
- BSE-21L.....
- BSE-24H.....
- BSE-24L.....

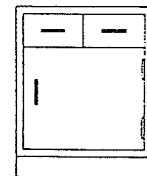

**2-DRAWERS
1-DOOR**

- BSI-15H.....
- BSI-15L.....
- BSI-18H.....
- BSI-18L.....
- BSI-21H.....
- BSI-21L.....
- BSI-24H.....
- BSI-24L.....

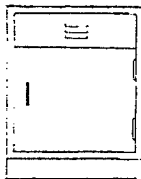

**SINK
CABINET**

- BSC-15HS.....
- BSC-15LS.....
- BSC-18HS.....
- BSC-18LS.....
- BSC-21HS.....
- BSC-21LS.....
- BSC-24HS.....
- BSC-24LS.....

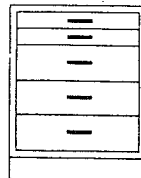

5-DRAWERS

- BSF-15H.....
- BSF-15L.....
- BSF-18H.....
- BSF-18L.....
- BSF-21H.....
- BSF-21L.....
- BSF-24H.....
- BSF-24L.....

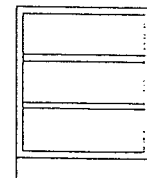

**OPEN
FRONT**

- BSJ-15H.....
- BSJ-15L.....
- BSJ-18H.....
- BSJ-18L.....
- BSJ-21H.....
- BSJ-21L.....
- BSJ-24H.....
- BSJ-24L.....

STAINLESS STEEL BASE CABINETS

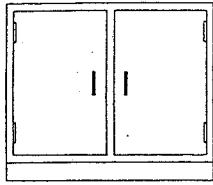

2-DOORS

- BDA-29H
- BDA-29L
- BDA-35H
- BDA-35L
- BDA-41H
- BDA-41L
- BDA-47H
- BDA-47L

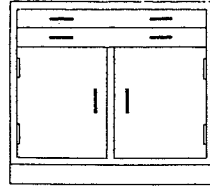

2-DRAWERS
2-DOORS

- BDE-29H
- BDE-35H
- BDE-41H
- BDE-47H

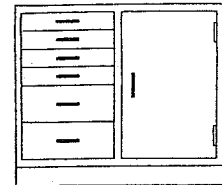

6-DRAWERS
1-DOOR

- BDI-29H
- BDI-29L
- BDI-35H
- BDI-35L
- BDI-41H
- BDI-41L
- BDI-47H
- BDI-47L

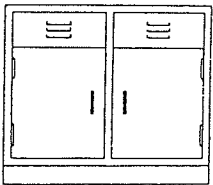

SINK
CABINET

- BDB-29HS
- BDB-35HS
- BDB-41HS
- BDB-47HS
- BDB-52HS
- BDB-58HS

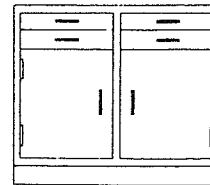

4-DRAWERS
2-DOORS

- BDF-29H
- BDF-29L
- BDF-35H
- BDF-35L
- BDF-41H
- BDF-41L
- BDF-47H
- BDF-47L

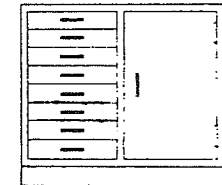

8-DRAWERS
1-DOOR

- BDJ-29H
- BDJ-35H
- BDJ-41H
- BDJ-47H

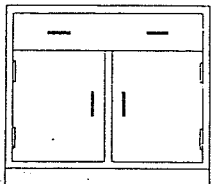

1-DRAWER
2-DOORS

- BDC-29H
- BDC-35H
- BDC-41H
- BDC-47H

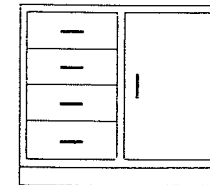

4-DRAWERS
1-DOOR

- BDG-29H
- BDG-29L
- BDG-35H
- BDG-35L
- BDG-41H
- BDG-41L
- BDG-47H
- BDG-47L

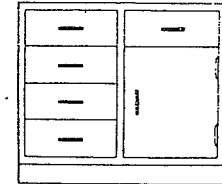

5-DRAWERS
1-DOOR

- BDK-29H
- BDK-35H
- BDK-41H
- BDK-47H

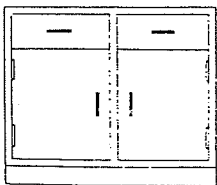

2-DRAWERS
2-DOORS

- BDD-29H
- BDD-29L
- BDD-35H
- BDD-35L
- BDD-41H
- BDD-41L
- BDD-47H
- BDD-47L

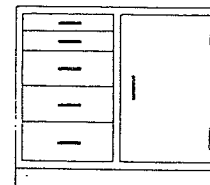

5-DRAWERS
1-DOOR

- BDH-29H
- BDH-35H
- BDH-41H
- BDH-47H

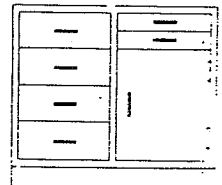

8-DRAWERS
1-DOOR

- BDL-29H
- BDL-35H
- BDL-41H
- BDL-47H



ADD FOR CARTONS

STAINLESS STEEL WALL CABINETS

ALL WALL CABINETS ARE 13 DEEP ...

"H" Models are 48" high.....with three adjustable shelves
 "M" Models are 36" high..... with two adjustable shelves
 "L" Models are 30" high..... with two adjustable shelves

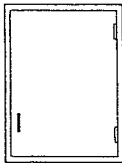
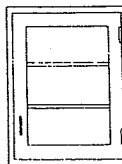
Model Nos. listed are left to right widths.

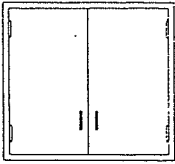
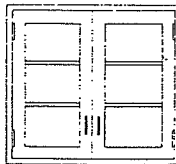
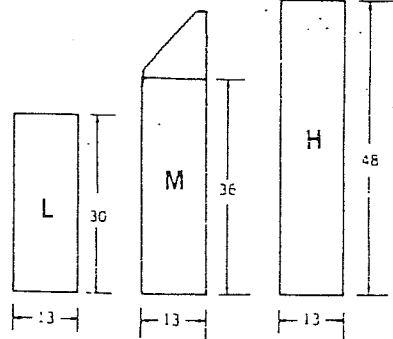
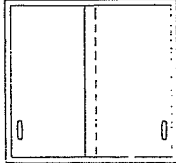
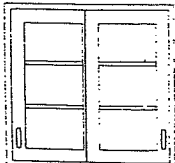
 <p>HINGED METAL DOOR</p> <p>WSA-18L..... WSA-18M..... WSA-18H..... WSA-24L..... WSA-24M..... WSA-24H.....</p>	 <p>HINGED GLASS DOOR</p> <p>WSD-18L..... WSD-18M..... WSD-18H..... WSD-24L..... WSD-24M..... WSD-24H.....</p>	 <p>OPEN FRONT</p> <p>WDG-18L..... WDG-18M..... WDG-18H..... WDG-24L..... WDG-24M..... WDG-24H..... WDG-29L..... WDG-29M..... WDG-29H..... WDG-35L..... WDG-35M..... WDG-35H..... WDG-41L..... WDG-41M..... WDG-41H..... WDG-47L..... WDG-47M..... WDG-47H.....</p>
 <p>HINGED METAL DOORS</p> <p>WDB-29L..... WDB-29M..... WDB-29H..... WDB-35L..... WDB-35M..... WDB-35H..... WDB-41L..... WDB-41M..... WDB-41H..... WDB-47L..... WDB-47M..... WDB-47H.....</p>	 <p>HINGED GLASS DOORS</p> <p>WDE-29L..... WDE-29M..... WDE-29H..... WDE-35L..... WDE-35M..... WDE-35H..... WDE-41L..... WDE-41M..... WDE-41H..... WDE-47L..... WDE-47M..... WDE-47H.....</p>	 <p>SIDE ELEVATION</p> <p>Sloping tops are available for all models. Priced on application.</p>
 <p>SLIDING METAL DOORS</p> <p>WDC-29L..... WDC-29M..... WDC-29H..... WDC-35L..... WDC-35M..... WDC-35H..... WDC-41L..... WDC-41M..... WDC-41H..... WDC-47L..... WDC-47M..... WDC-47H.....</p>	 <p>SLIDING GLASS DOORS</p> <p>WDF-29L..... WDF-29M..... WDF-29H..... WDF-35L..... WDF-35M..... WDF-35H..... WDF-41L..... WDF-41M..... WDF-41H..... WDF-47L..... WDF-47M..... WDF-47H.....</p>	

ADD FOR CARTONS

STAINLESS STEEL HIGH CABINETS

All High Cabinets are 84" high.

"A" Models are 18" front to back.

"B" Models are 23" front to back.

ALL MODELS ARE PROVIDED WITH FIVE ADJUSTABLE SHELVES.

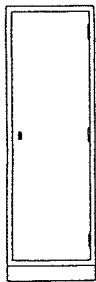

HINGED METAL DOOR

- HSA-18A
- HSA-18B
- HSA-24A
- HSA-24B

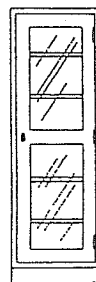

HINGED GLASS DOOR

- HSD-18A
- HSD-18B
- HSD-24A
- HSD-24B

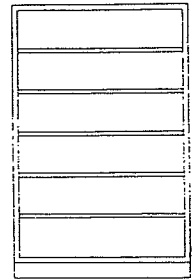

OPEN FRONT

- HDG-18A
- HDG-18B
- HDG-24A
- HDG-24B
- HDG-29A
- HDG-29B
- HDG-35A
- HDG-35B
- HDG-41A
- HDG-41B
- HDG-47A
- HDG-47B

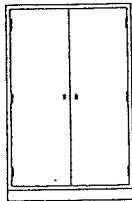

HINGED METAL DOORS

- HDB-29A
- HDB-29B
- HDB-35A
- HDB-35B
- HDB-41A
- HDB-41B
- HDB-47A
- HDB-47B

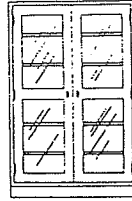

HINGED GLASS DOORS

- HDE-18A
- HDE-18B
- HDE-35A
- HDE-35B
- HDE-41A
- HDE-41B
- HDE-47A
- HDE-47B

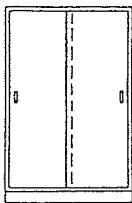

SLIDING METAL DOORS

- HDC-29A
- HDC-29B
- HDC-35A
- HDC-35B
- HDC-41A
- HDC-41B
- HDC-47A
- HDC-47B

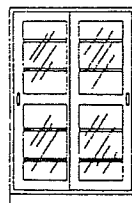

SLIDING GLASS DOORS

- HDF-29A
- HDF-29B
- HDF-35A
- HDF-35B
- HDF-41A
- HDF-41B
- HDF-47A
- HDF-47B

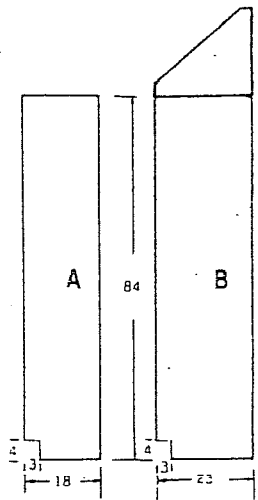

SIDE ELEVATION

Sloping tops are available for all models.
Priced on application.

ADD FOR CARTONS

STAINLESS STEEL COMBINATION CABINETS

Combining a standard 48" high wall cabinet mounted on a standard 35-1/4" high base cabinet. A Stainless Steel Work Area is provided at front with a one inch overhang.

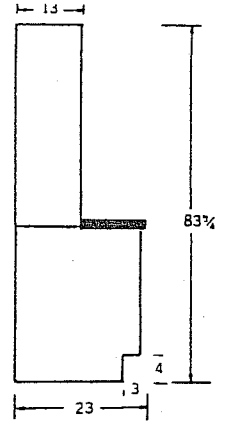

SIDE ELEVATION

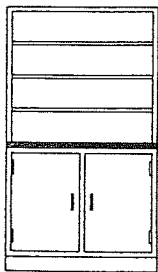

OPEN
SHELVING
2-DOORS

- CA-29
- CA-35
- CA-41
- CA-47

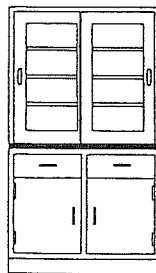

SLIDING
GLASS
DOORS
2-DRAWERS
2-DOORS

- CB-29
- CB-35
- CB-41
- CB-47

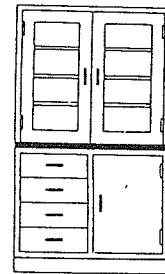

HINGED
GLASS
DOORS
4-DRAWERS
1-DOOR

- CC-29
- CC-35
- CC-41
- CC-47

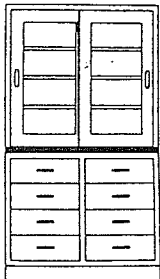

SLIDING
GLASS DOOR
8-DRAWERS

- CD-29
- CD-35
- CD-41
- CD-47

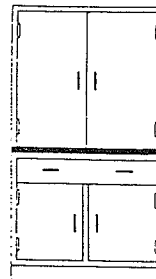

HINGED
METAL
DOORS
1-DRAWER
2-DOORS

- CE-29
- CE-35
- CE-41
- CE-47

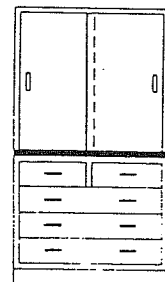

SLIDING
METAL
DOORS
5-DRAWERS

- CF-29
- CF-35
- CF-41
- CF-47

WORK TOPS

16 GAUGE STAINLESS STEEL NO. 4 FINISH

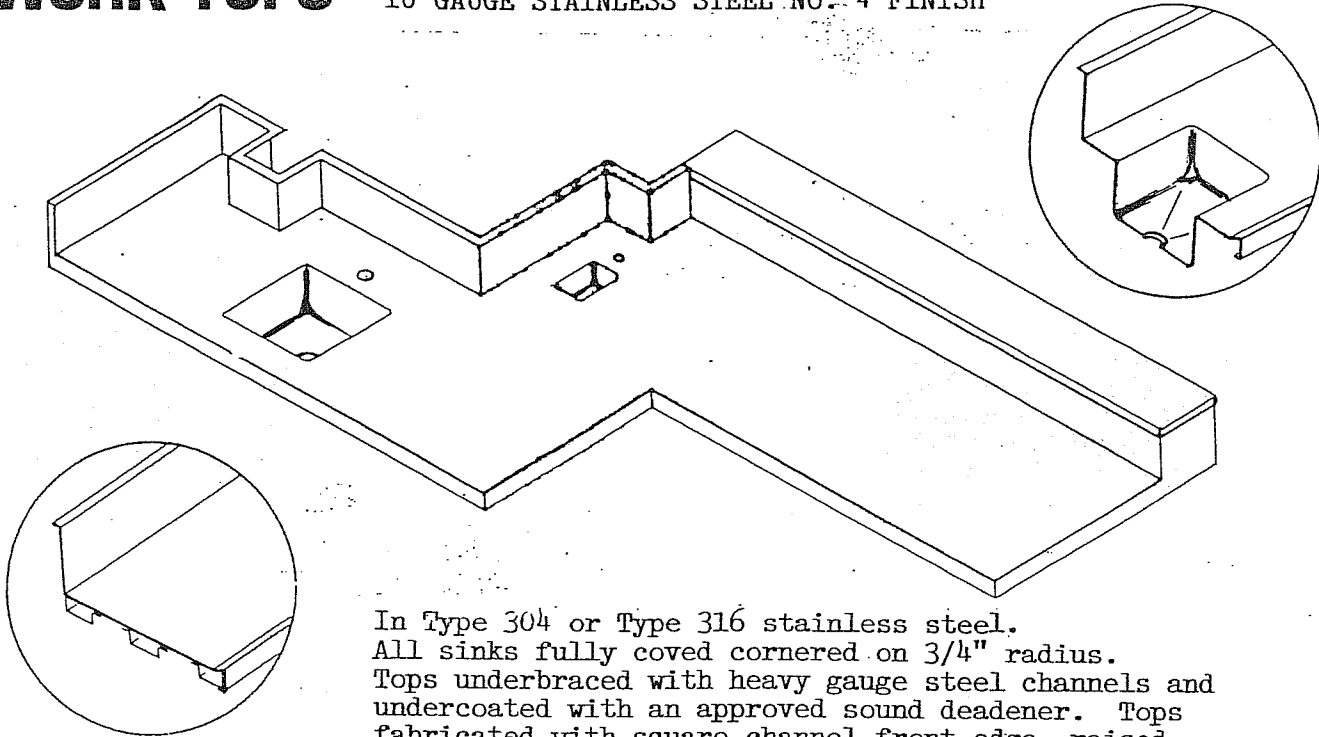

In Type 304 or Type 316 stainless steel.
All sinks fully covered cornered on 3/4" radius.
Tops underbraced with heavy gauge steel channels and undercoated with an approved sound deadener. Tops fabricated with square channel front edge, raised "v" front edge or marine edge.
Send us your requirements for pricing:

ALL CUSTOM BUILT

STAINLESS STEEL FUME HOODS

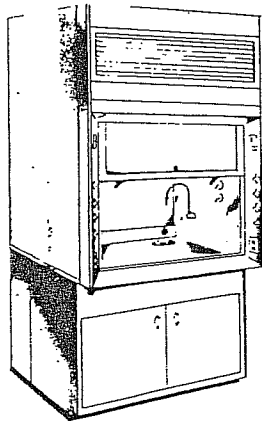

Standard and Special Purpose Fume Hoods, ruggedly constructed and engineered to your most exacting requirements.

NOURISHMENT STATIONS

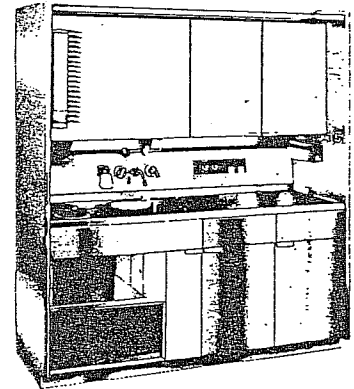

Full food service work stations with ice systems, hot and cold liquids, hot plates, sinks, refrigerator, light fixtures, storage space, and more.

UMC has over a half century of varied "expertise" in high quality Stainless Steel Sheet Metal Fabrication for Institutional, Commercial, and Industrial products with COVERED CORNERS our specialty.

WE INVITE YOUR INQUIRIES AND DRAWINGS FOR OUR PRICING.

STAINLESS STEEL

OPERATING ROOM CABINETS

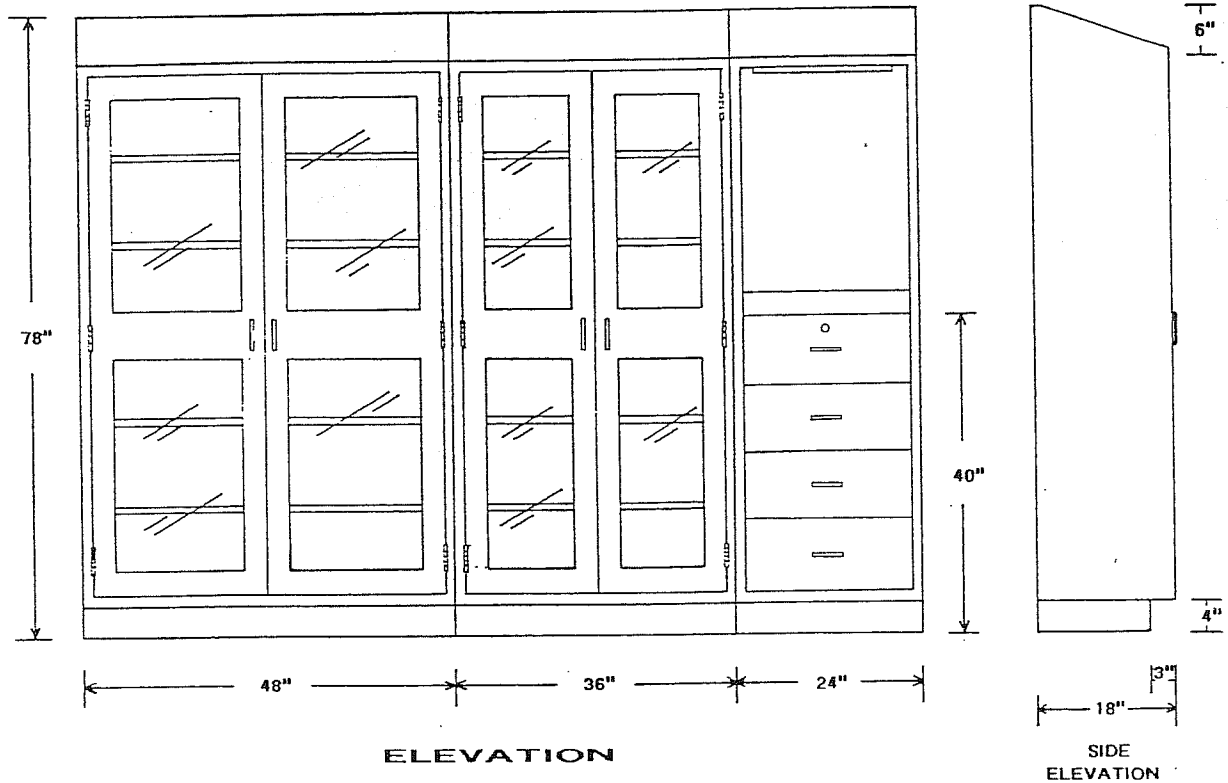

ALL UNITS CONSTRUCTED OF 18 GA TYPE 304 STAINLESS STEEL WITH NO. 4 FINISH. ALL FACING JOINTS FULLY WELDED, GROUND, AND POLISHED TO A SATIN FINISH.

SUPPLY/EQUIPMENT CABINETS INCLUDE FIVE(5) SHELVES ADJUSTABLE ON 1/2" CENTERS AND SLOPED TOPS. DOORS OF 1/4" SAFETY PLATE GLASS ARE FLUSH-MOUNTED ON THREE S/S HINGES PROVIDED WITH GRASP HANDLES AND SPRING-LOADED NYLON ROLLER CATCHES ON TOP AND BOTTOM.

DESK UNIT PROVIDED WITH FOUR(4) DRAWERS, TOP WITH CYLINDER LOCK; 3" SLOPED DESKTOP; FLUORESCENT LIGHT; AND BULLETIN BOARD BACK. DRAWERS OPERATE ON S/S CHANNEL SLIDES WITH NYLON BALL BEARINGS.

NARCOTIC LOCKERS

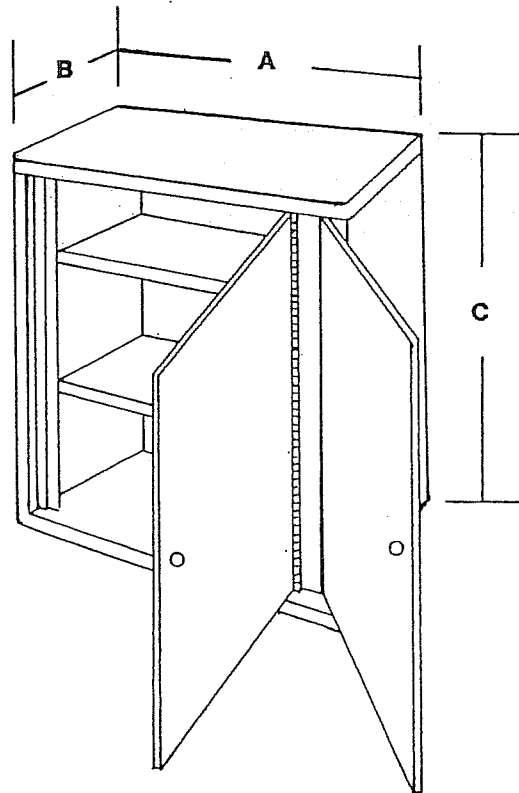

WALL MOUNTED UNIT CONSTRUCTED OF 18 GAUGE TYPE 304 STAINLESS STEEL. INNER DOOR OF 1/8" THICKNESS AND OUTER DOOR IS DOUBLE-WALLED. THE DOORS ARE SEPARATELY LOCKED AND KEYED DIFFERENTLY. INTERIOR DOOR KEY CANNOT BE REMOVED WHEN LOCK IS IN OPEN POSITION.

UNIT IS ALSO PROVIDED WITH TWO(2) ADJUSTABLE SHELVES.

A	B	C
12" X	8" X	15"
14" X	10" X	18"
18" X	12" X	24"
24" X	12" X	30"
36" X	12" X	30"

OTHER SIZES
AVAILABLE
UPON REQUEST

STAINLESS STEEL TABLES

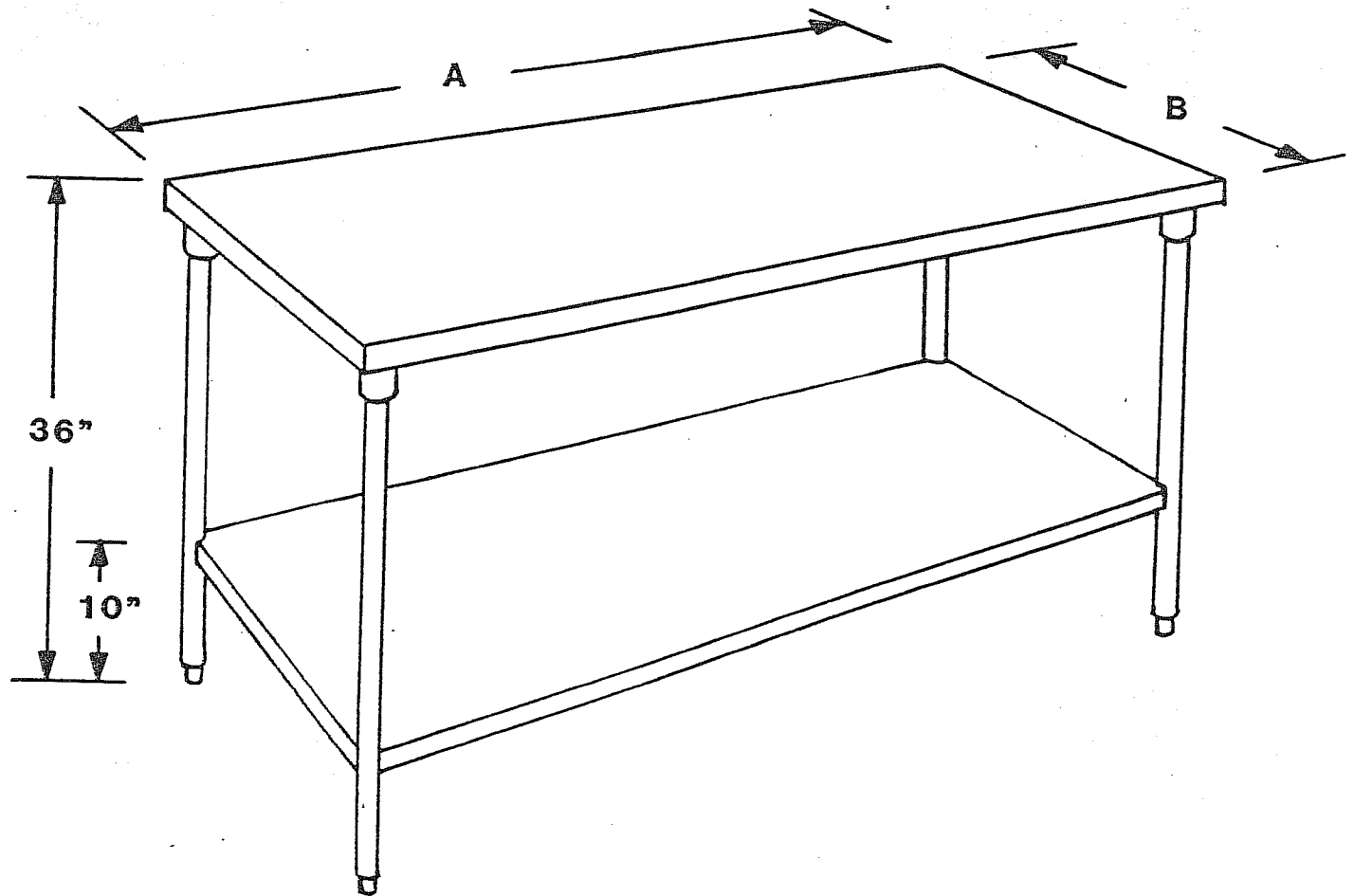

TOP CONSTRUCTED OF 14 GAUGE TYPE 304 STAINLESS STEEL. ALL EDGES TURNED DOWN 90° WITH 2" FLANGE AND 1/2" UNDERBEND. TOP REINFORCED WITH CHANNEL FRAMING. FULLY SOUND DEADENED. UNDERSHELF MOUNTED 10" ABOVE FLOOR CONSTRUCTED OF 16 GAUGE STAINLESS STEEL. 1-5/8" O.D. STAINLESS STEEL TUBULAR LEGS WITH ADJUSTABLE BULLET FEET.

SINKS

WALL-MOUNTED

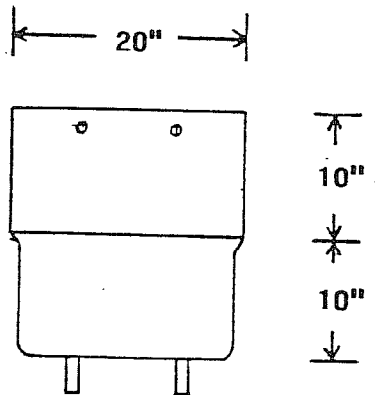

20" WIDE X 24" DEEP X 20" HIGH

TYPE 304 14 GAUGE S/S NO. 4 FINISH

S/S BRACKETS

ROLLED EDGE

FREE-STANDING

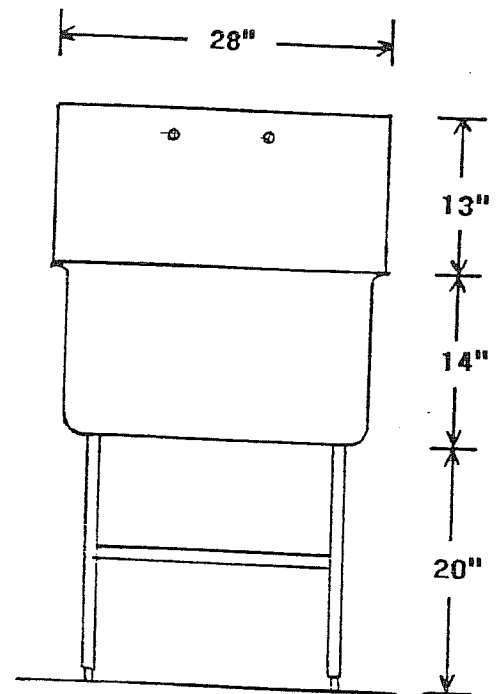

28" WIDE X 28" DEEP X 47" HIGH

TYPE 304 14 GAUGE S/S NO. 4 FINISH

1-5/8" O.D. S/S TUBING

ADJUSTABLE FEET

ROLLED EDGE

SOAK SINKS

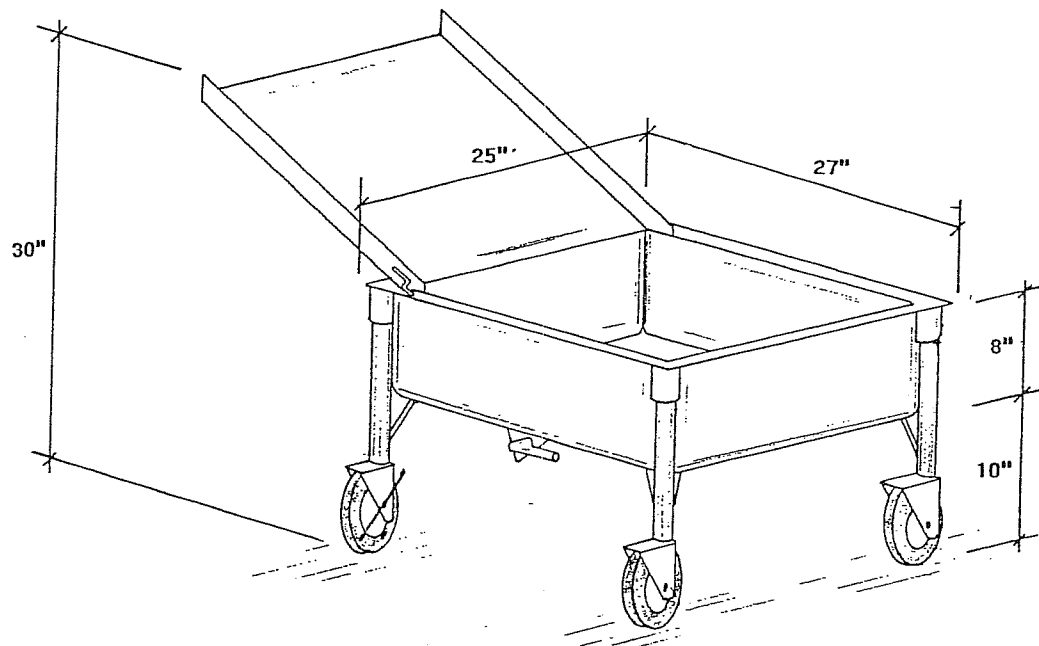

#14 GAUGE CRS ALL WELDED 3/4" ROUND/COVED
CORNERED CONSTRUCTION; MOUNTED ON
4-STAINLESS STEEL TUBULAR LEGS WITH CASTERS.

SCRUB SINKS

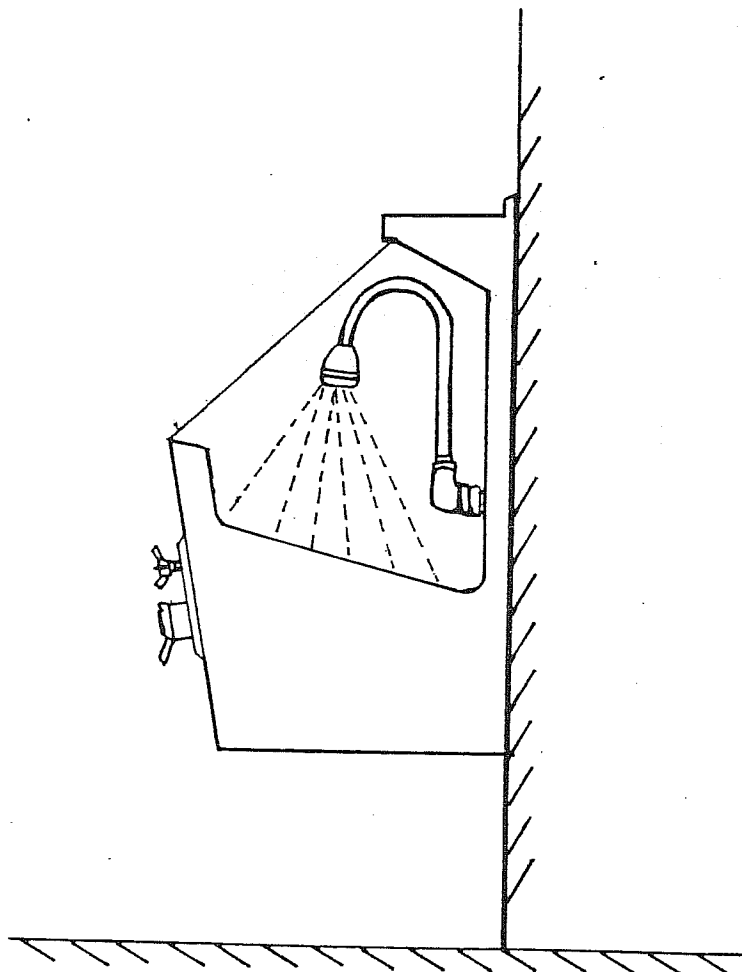

**SINGLE OR MULTIPLE
BAY SINKS AVAILABLE**

**CONSTRUCTED OF NO. 16 TYPE 304
STAINLESS STEEL NO. 4 SATIN FINISH.**

**DIVIDER PANELS OF PLEXIGLASS
OR S/S.**

**ALL WELDED CONSTRUCTION.
ALL CORNERS COVED TO 1" RADIUS.**

**SLOAN VALVE CO #ETF-75 OPTIMA
AUTOMATIC WATER CONTROL VALVE
W/INFRARED SENSOR OR EQUAL.**

**LEONARD #M-10-C TEMPERATURE
CONTROLLER OR EQUAL.**

FABRICATED TO REQUIREMENTS